

R.S. Clymo

**MODELS OF PEAT GROWTH**

Clymo, R.S. 1992: Models of peat growth. — Suo 43:127-136. Helsinki. ISSN 0039-5471

Models reflect reality but also simplify it. The modeller must choose where the balance lies between simplicity plus understanding and complexity plus realism. (1) Two pictorial and descriptive models of the surface of a peat-forming bog are given, and a third shows why the true rate of peat accumulation must diminish over time. (2) A simple quantitative model of the surface layers is described and leads to the conclusion that the surface layer is in a steady state, fixing carbon, losing some by decay, and passing some on to the underlying peat proper. A similar model for the underlying peat shows that if decay is at a rate that is a constant proportion of what remains then there is an upper asymptotic limit to the depth of peat. But if the rate of decay decreases, because the remaining material is more refractory, then peat accumulation continues indefinitely though at an ever-decreasing rate. (3) A simulation model allowing greater realism but diminished understanding is outlined. (4) Models should be aids, not objects in their own right.

Keywords: Carbon balance, modelling, peat growth, peatland

*R.S. Clymo, School of Biological Sciences, Queen Mary and Westfield College, London E1 4NS, UK*

**INTRODUCTION**

A model represents one or more features of the real world, chosen by the modeller as being important. The model is simpler than the real world and is therefore easier to manipulate and understand. On one hand is Scylla: if the model is too simple it will not mimic behaviour in the real world satisfactorily. On the other hand Charybdis waits to engulf a too-complex model in a welter of detail from which all understandability has departed. The modeller has to choose the strait path between these opposing dangers, and to suit the model to its purposes.

It is convenient to recognise three sorts of purpose:

- (TE) teaching or educating;
- (UC) understanding the consequences of assumptions;
- (PB) predicting behaviour in specified circumstances.

It is also convenient to recognise three sorts of model:

- (Ql) qualitative, perhaps pictorial;
- (Qt) quantitative;
- (Si) simulation — probably complex but realistic behaviour.

These sorts of models are not usually of equal value for all three purposes. The following matrix indicates the commonest usage in a broad way:

		Sort of model:		
		Ql	Qt	Si
Purpose:	TE	++	++	.
	UC	.	++	+
	PB	.	+	++

In what follows I give examples of different sorts of models concerned with peat growth.

## QUALITATIVE MODELS

### A pictorial and descriptive model

The simplest sort of model is shown in Fig. 1. This takes a *Sphagnum* carpet as an exemplar of a great many possible models. Matter is added by photosynthesis at the surface. The *Sphagnum* canopy is surprisingly dense and the euphotic zone — that within which 0.99 of incident light is absorbed — is barely 2–4 cm deep (Clymo & Hayward 1982). In the darkness below it most of the leaves die. The dry bulk density is only about  $0.03 \text{ g cm}^{-3}$  so the structure is open. Water can run down among the plants easily and gases can circulate by mass flow as well as diffusion. There is plenty of  $\text{O}_2$  so aerobic decay is the dominant process mediated mainly by fungi.

At first the macroscopic structure survives, perhaps supported in part by vascular plants growing among the *Sphagnum*, rather as isolated bricks may be removed from a wall without it collapsing. Eventually, however, the macroscopic structure does collapse partly from the pressure exerted by the continually increasing mass above (most of it water in the unsaturated zone) and partly perhaps from a seasonal load of snow on an as yet unfrozen surface. The bulk density increases perhaps 4-fold to  $0.12 \text{ g cm}^{-3}$  and the spaces between structural elements decrease by the same factor. The volume rate of flow of water is approximately dependent on the fourth power of the channel size, so the resistance to flow increases by about  $4^4 = 256$ -fold: the peat as it is now has become much less permeable, and surplus water runs off laterally. For most of the year there is surplus water, and even when there

has been a drought the layer which has begun to drain fills rapidly again on the first substantial rain. Indeed the whole system is beautifully self-regulating for the hydraulic conductivity increases logarithmically upwards (Bragg 1982, shown in Clymo 1991). As the water level rises so it becomes easier for it to flow away, just as it does in a V-notch weir. The residence curve, shown in Fig. 2, is 'S' shaped, and for two-thirds of the time the water table fluctuates by no more than a few centimetres.

In the porous surface layer  $\text{O}_2$  is abundant. Below the water table micro-organisms use up the  $\text{O}_2$  in solution where it is ten-fold less abundant on a volumetric basis than it is in air. It is replenished mainly by diffusion, and this is about  $10^4$ -fold slower in water than in air. No comparable mass flows. In consequence the micro-organisms create anoxic conditions and below this level decay — mainly by bacteria — is anaerobic. This anaerobic decay is much slower for reasons which are unclear, than the aerobic process and it is this slowness of decay that is the direct cause of peat accumulation.

The term acrotelm was introduced by Ingraham (1978) for these surface layers down to the depth to which the water table drops in a dry summer. The acrotelm is a region of many and various changes. It takes in  $\text{CO}_2$ , converts it to plant material, modifies it in various ways, then passes it on to the lower layer — the catotelm. The acrotelm, once established, remains of approximately constant thickness at perhaps 10–50 cm. The catotelm however increases in thickness for at least 5–10 millennia, and the catotelm is the true site of peat accumulation.

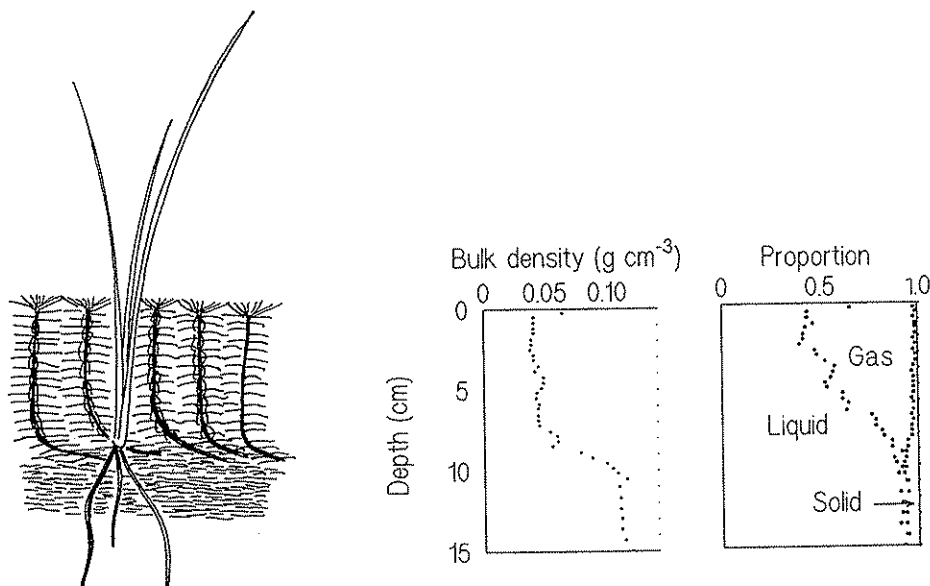

Fig. 1. Pictorial model of the surface of a *Sphagnum*-dominated peat-bog with a representative monocotyledonous rooted vascular plant.

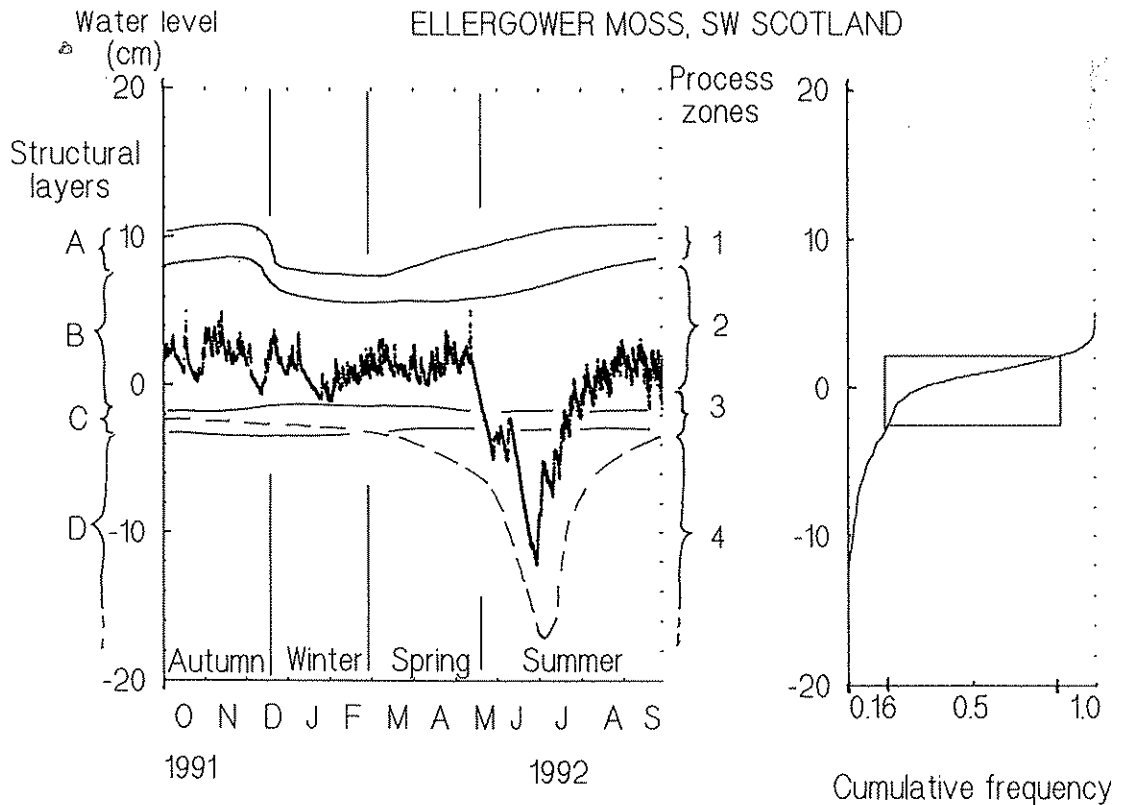

Fig. 2. Four structural layers (left): A, green; B, litter-peat (Malmer 1991); C, collapse; D, peat proper. Four functional zones (right): 1, euphotic; 2, aerobic decay; 3, transition; 4, anaerobic decay. Zones 2-4 move up and down through the structural layers with an annual cycle. The watertable and the residence-time diagrams are for the 1991/92 hydrological year. The box in the residence-time graph defines the proportions 0.16 to 0.84 (one S.D.) on either side of the mean in the Gaussian case.

Of course there are many variants of this qualitative model. The influence of roots in adding mass below the surface (Wallén 1992), or as conduits into the catotelm for gases, and the influence of dwarf shrubs supporting the acrotelm structure are obvious examples. The model can also be extended more radically to include trees.

#### A structure-and-function-model

A second version of the model is shown in Fig. 2 based on Clymo (1992). Here we see a distinction made between four layers of structure at the left (green, litter-peat, collapse, peat proper) and four functional zones at the right (euphotic, aerobic decay, transition, anaerobic decay). These layers and zones have been described above, but the model of Fig. 2 makes explicit that the process zones do not in general bear a fixed relation to the structural layers: they move up and down through them seasonally and, over the course of years, the acrotelm moves up past any particular piece of plant matter.

#### A pictorial process model

The model in Fig. 3 enshrines the essential truth, that if the rate of input is constant but decay is proportional to the whole mass accumulated so far, then the true rate of accumulation decreases with time and (if the proportional rate of decay is constant) eventually approaches zero: the system makes an asymptotic approach to a limiting maximum depth. Whether this is realistic or not is not, here, the issue. The model is useful in so far as it points to an unavoidable consequence of simple and not unrealistic assumptions.

#### QUANTITATIVE MODELS

##### The aim

Quantitative models increase understanding and allow tests against observable behaviour. Those cast in the form of analytical solutions to model equations that enshrine the assumptions are particularly useful as one may see immediately and

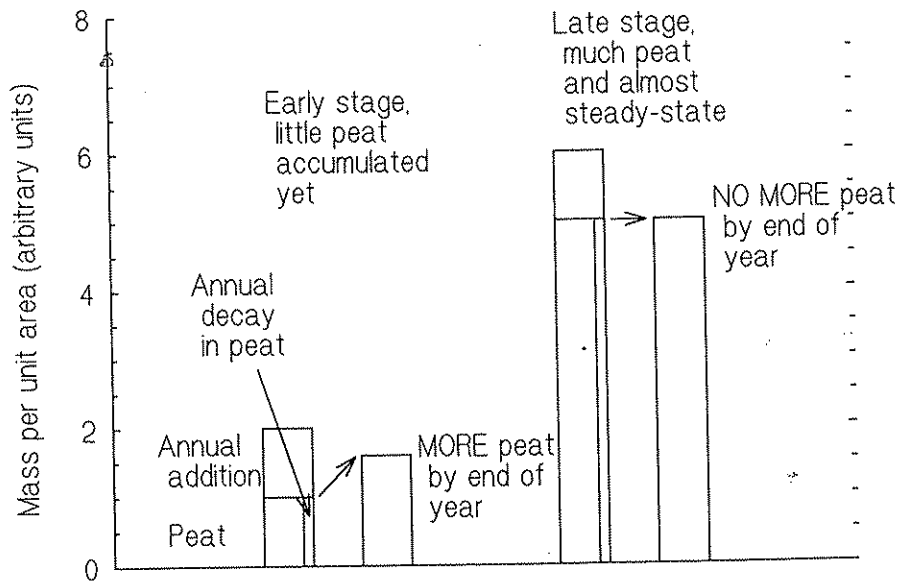

Fig. 3. Pictorial diagram indicating how the true rate of accumulation decreases with time. At the left, at an early stage of development, the annual rate of addition exceeds the combined loss by decay from all depths. At the right, when much more peat has accumulated, the annual addition at the surface (which is as green and healthy as it was earlier) is exactly the same but losses occur throughout a much greater mass of peat. Collectively they almost equal the addition, so there is virtually no net accumulation.

with certainty what consequences follow from the assumptions.

### The acrotelm

Consider, first, the dynamics of the acrotelm, and follow the ideas illustrated in Fig. 3. Assume that organic matter is added at the surface at a rate  $p$  (for productivity) that is constant from year to year. Let the total organic matter accumulated to date be  $M$ . Decay affects the whole of this. For simplicity assume that a constant proportion,  $\alpha$ , of  $M$  decays each year. We may now write these assumptions in the continuous form as:

$$dM/dt = p - \alpha M \quad (1)$$

The solution to (1) is:

$$M_t = (p/\alpha)(1 - \exp[-\alpha t]) \quad (2)$$

The graph of this is shown in Fig. 4b. One can see that the accumulated mass approaches an upper limit, which equation (2) shows to be  $p/\alpha$ . This model is simple, explicit, and its consequences are readily understood. But the assumption that the rate of decay is constant may seem unrealistic. There are few suitable sets of data on which to test it. One set for the sub-Antarctic moss *Chorisodontium aciphyllum* (Baker 1972) is shown in Fig. 4a. A constant rate of decay amounts to a negative exponential decline in mass with time: for decay alone

$$dM/dt = -\alpha M \quad (3)$$

from which it follows that

$$M_t/M_0 = \exp(-\alpha t) \quad (4)$$

The data suggest that a sigmoid shape might be more accurate than the negative exponential. There are many equations that give a sigmoid shape. Given the experimental scatter there is no way of deciding whether one is a better fit than another, and none of them has simple biological assumptions behind it. For illustration consider

$$M_t/M_0 = 1 - (1 - v)/(1 + \exp[-r(t - T)]) \quad (5)$$

Here  $v$  is the base toward which the curve tends as asymptote, and represents the proportion of refractory material;  $r$  determines the steepness of the slope just as  $\alpha$  did in (2); and  $T$  is the time at the steepest downward slope. The solution is given in Clymo (1991) and is shown in Fig. 4c.

Should one choose (4) or (5)? Within the range of the data they produce very similar peat growth curves (Fig. 4b) which begin to differ only after 60 years or so when the refractory element assumed in (5) begins to exert its influence. The assumptions behind (4) are easily grasped, have a clear biological meaning, and require only one parameter,  $\alpha$ . Equation (5) does not have an easily understood biological origin — it is simply an *ad hoc* equation with the necessary shape — and it requires three parameters. But it is a better fit to the data in Fig. 4a. Equation (4) might be said to be indigenous to the situation while (5) is exotic (Skellam 1972). The modeller must judge where the balance of advantage lies.

The curves of Fig. 4a refer to moss-banks in the sub-Antarctic, but similar curves must hold for the acrotelm of boreal peatlands. An important concept now appears. The slope of the curve at any point has the physical nature of a mass  $p$

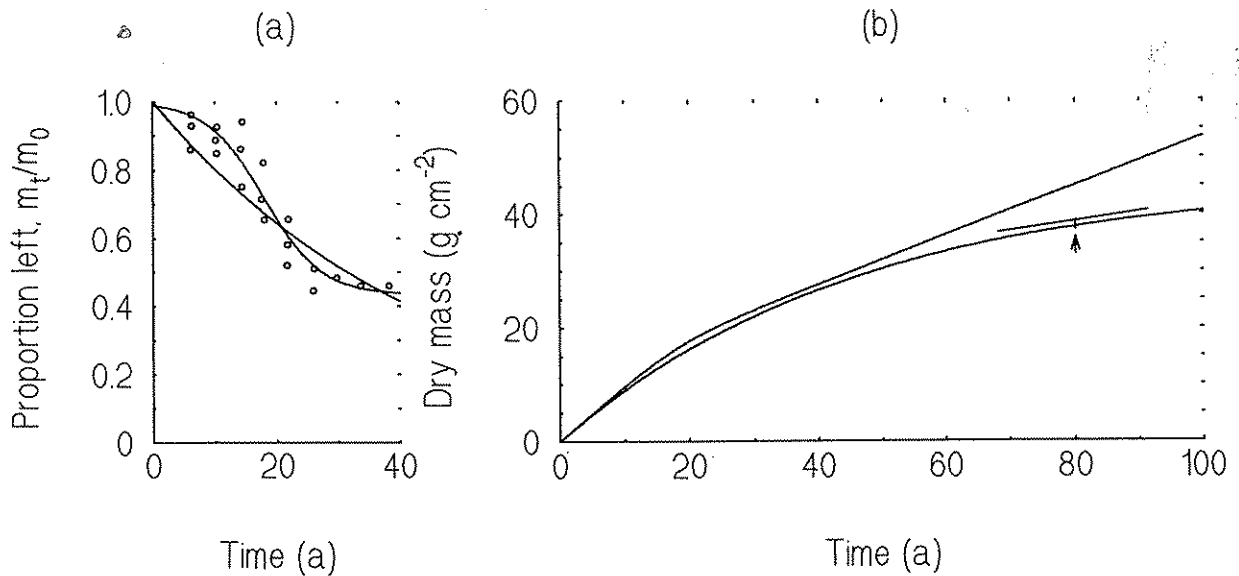

Fig. 4. (a) Course of decay of *Chorisodontium aciphyllum*. The fitted shapes are those of equation (4) — the negative exponential and (5) — a sigmoid. (b) Course of accumulation of dry matter in the acrotelm based on equation (2) which incorporates negative exponential decay (4), and the equation in Fig. 9 of Clymo (1991) which incorporates sigmoid decay (5). The base of the acrotelm is put at 80 years and the slope there gives  $p'$ , the rate at which the acrotelm supplies matter to the catotelm. The depth of the acrotelm is similar in both cases, but for the negative exponential  $p'/p = 0.18$  whereas for the sigmoid it is 0.43.

unit area divided by time i.e. its physical dimensions,  $ML^{-2}T^{-1}$ , are those of a productivity. At  $t = 0$ , before decay has begun, the slope is, in fact, the productivity  $p$  in equation (1). At the point where the water table engulfs the bottom of the acrotelm the slope shows the rate at which dry matter is entering the catotelm. It is exactly analogous to the addition at rate  $p$  to the acrotelm. Let it be shown as  $p'$ . Then equation (1) can be extended to define the whole acrotelm by

$$dM/dt = p - \alpha M - p' = 0 \quad (6)$$

This makes explicit that the acrotelm, once established, is not increasing in mass (thickness). It takes in matter at rate  $p$ , modifies it, and passes what is left on at rate  $p'$  to the catotelm. The quotient  $p'/p$  is about 0.1–0.2 (Clymo 1984).

### The catotelm

One may apply the same approach to the catotelm. Matter is added at a rate  $p'$  at the top, then decays. In the acrotelm there was some evidence to guide the choice of decay rule, but in the catotelm, where time scales are in millennia rather than in decades, there is none. One may make assumptions, then devise testable consequences. The original as-

sumption (Clymo 1984) was that  $p'$  and the proportional rate of decay,  $\alpha'$ , were constant. One consequence was that age vs depth (as cumulative mass per unit area) curves should be concave. Many examples are so, though some are not (Clymo 1991). Given the simplicity of the assumptions it is surprising that any examples give a reasonable fit. An important consequence of the model is that there is an asymptotic maximum to the depth of peat at  $p'/\alpha'$ . It seems, then, that the simple assumptions that decay rate is directly proportional to the mass remaining, and that  $p'$  and  $\alpha'$  are constant over many millennia, are broadly sufficient. But that does not show that they are correct. One may make other assumptions using the method in the Appendix to build a model. In Table 1 and Fig. 5 are the consequences of four such assumptions. All specify that the rate of decay is applied to the mass remaining. The first case is that already described: the rate is constant and does not itself depend on how much has already decayed. The second case assumes that the rate declines linearly with the amount remaining i.e. that the material left is increasingly refractory, but does still decay. The third case is similar but assumes that the decline follows a concave, specifically quadratic curve. The last

Table 1. Solutions of peat growth equations (Appendix).

Decay rule	Name	$M_T =$	Limiting shape
$\alpha' = a'$	Constant	$\frac{p'}{a'} [1 - \exp(-a'T)]$	Asymptote $p'/a'$ as $T \rightarrow \infty$
$\alpha' = a'\mu$	Linear	$\frac{p'}{a'} [\ln(1 + a'T)]$	Logarithmic with $T$
$\alpha' = a'\mu^2$	Quadratic	$\frac{p'}{a'} \sqrt{1 + 2a'T} - 1$	Parabolic with $T$
$\mu < r, a' = 0$	Refractory	—	Linear, slope $p'r$ as $T \rightarrow \infty$

case assumes a proportion of material is completely refractory and does not decay however long it is left (but there is not a general analytic solution for this case). The consequent equations specifying the time-course of mass accumulation,  $M_T$ , are shown for the first three cases in Table 1 and in Fig. 5b. The limiting shapes form a series. The first, constant, case — the one considered in Clymo (1984, 1991) — is asymptotic to an upper limit of  $p'/\alpha'$ . The other three are not asymptotic. In the second, linear, case  $M_T$  changes with

the logarithm of time; in the third, quadratic, case  $M_T$  is a parabola with time. Both have the character that, though there is no maximum depth, the depth increases at an ever-decreasing rate. The fourth, refractory, case (not shown in Fig. 5) differs in settling to a steady rate of increase of  $p'r$ , where  $r$  is the proportion of matter that is completely refractory.

These different models thus have different consequences. The evidence against which they may be tested is age vs depth curves. The results

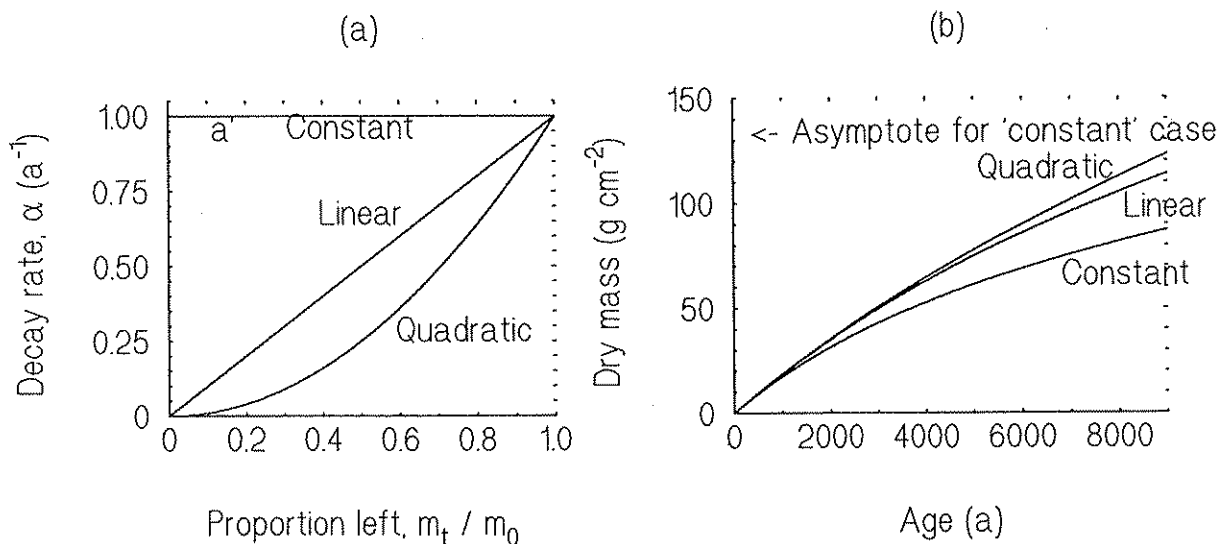

Fig. 5. (a) Assumptions about how the decay coefficient,  $a'$ , depends on the proportion of mass remaining. For the top line  $a'$  (Table 1) is constant; for the middle it decreases linearly, corresponding to increasingly refractory material the bottom line is quadratic and shows a more rapid transition but to a smaller proportion of refractory material. (b) Course of peat accumulation using the three decay models of Fig. 5(a), following the equations in Table 1. In each case  $p' = 0.02 \text{ g cm}^{-2} \text{ a}^{-1}$ ,  $a' = 0.00015 \text{ a}^{-1}$  (values similar to those in Fig. 6). The constant decay tends toward an asymptote at  $p'/a' = 133 \text{ g cm}^{-2}$ . The other two cases increase indefinitely but at steadily decreasing rates.

of such tests are shown in Fig. 6. There is no compelling reason for choosing one of the three models rather than another except that the precision of the estimation of the parameter,  $\alpha'$ , is rather greater for the constant case than for the linear and quadratic ones. The evidence is a gentle curve. Given the fact there will always be some random variation in such age vs depth curves span-

ning five millennia or more then it is never going to be possible to make a convincing choice between these models on this sort of evidence. The only real reason for preferring the constant model is that it is the simplest — but it is not the most plausible. We really need models that predict more complex behaviour, or predict the behaviour of more variables. Soon after setting off this route

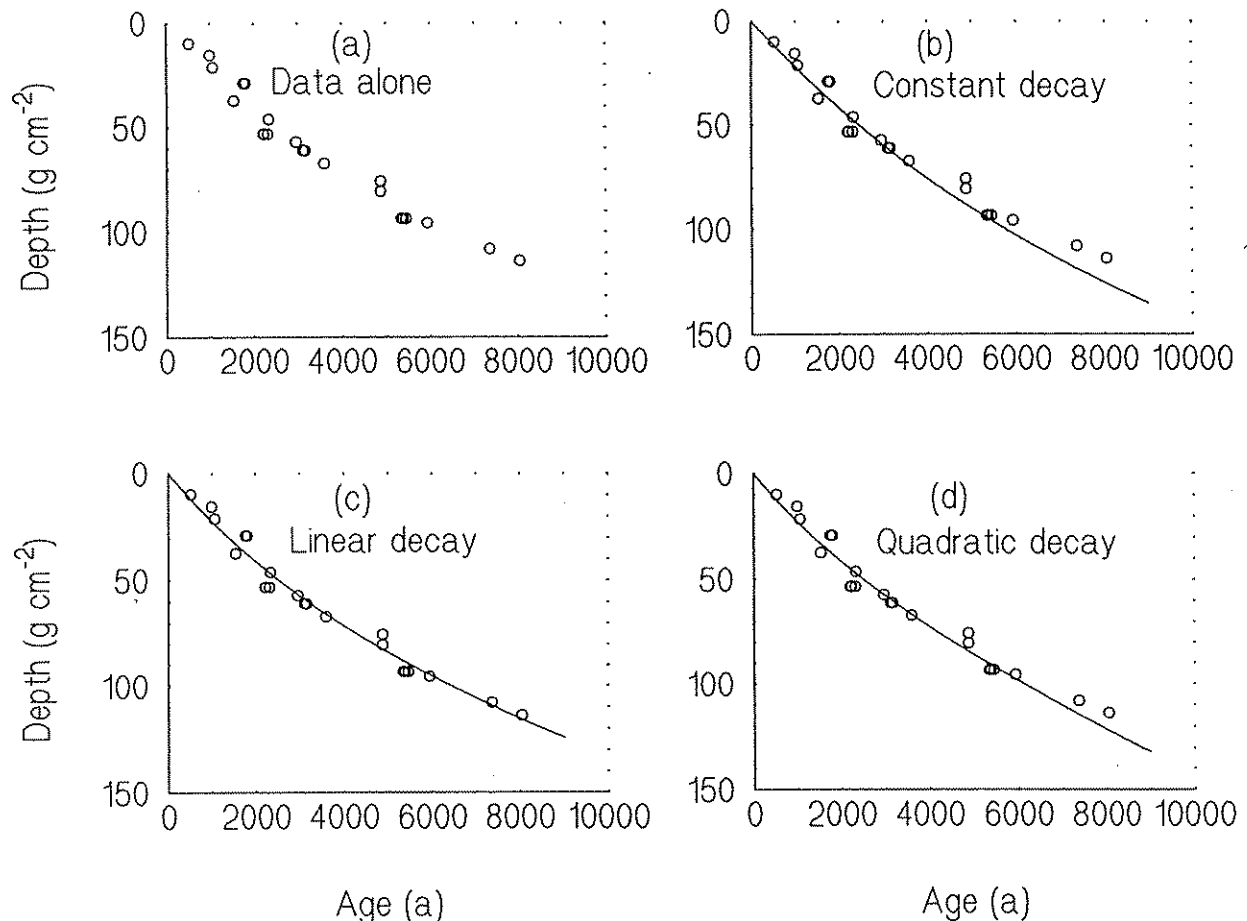

Fig. 6. Age vs depth (as cumulative dry mass below the surface) for the Point Escuminac peatland, New Brunswick (Warner, Clymo & Tolonen 1993). (a) Data. (b) Fitted according to the constant decay model. (c) Fitted to the linear decay model. (d) Fitted to the quadratic decay model. A total of 22 samples were taken for C-14 measurements. These were calibrated using the 20-yr data in the programme CALIB of Stuiver and Reimer (1986). The oldest five samples were beyond the reach of calibration at present. Of the 16 with C-14 age <7250 radiocarbon yr four gave three alternative dates. The line was fitted using the simplex procedure of Nelder and Mead (1965). Ages and masses were standardised to unit mean. Let the horizontal and vertical differences from the fitted line be  $u$  and  $v$  respectively. The optimised function was the sum of squares of the nearest distances  $u^2v^2/(u^2 + v^2)$ , weighted by the inverse of the uncertainty in the age and the number of alternative dates. The fitted parameter values,  $p'$  and  $a'$ , are:

Decay model	$p'$ ( $\text{g cm}^{-2}\text{a}^{-1}$ )	$a'$ ( $\text{a}^{-1}$ )	$f$	$r$
Constant	0.0231 [36]	0.000104 [59]	0.31	0.95
Linear	0.0248 [38]	0.000215 [121]	0.27	0.98
Quadratic	0.0256 [44]	0.000288 [173]	0.34	0.99

Values in brackets are standard errors as % of the mean. The function value at the minimum is shown as 'f'. The correlation between parameters as 'r'. The high values of  $r$  reflect the fact that  $p'$  is determined by the general slope, while  $a'$  is set by the concavity. A small change in one can be closely compensated by a small change in the other.

we reach simulations, where realism of behaviour increases, but understanding and testability decrease.

## SIMULATION MODELS

### General

Simulation models may be more realistic than the quantitative ones just described but they are black boxes, whose behaviour can be studied by experiment but cannot be predicted exactly.

One of the most ambitious simulation models of peatland growth was constructed by Wildi (1978). He included amount of peat, amount of water, amount of solutes, biomass of bog plants, and biomass of fen plants. The processes were controlled by 20 parameters. The values for the five variables were specified at each point in the simulated bog. Adjacent sites were specified as being at different heights, thus generating flow of water and solutes. The model simulated peat growth in relation to topography, and (in a fairly crude way) successional changes. Some of the predictions could be tested in a qualitative way.

### 'Forrester' simulation models

A powerful aid in constructing simulation models is the systematic approach developed by Forrester (1961), illustrated in outline in Fig. 7.

Boxes contain amounts of a chosen variable. Arrows indicate flows. These flows must be of the same notional substance. In a peat growth model, for example, plant matter can 'move' from the acrotelm to the catotelm. But it must be kept separate from the parallel flows of water, energy and length. One may imagine circumstances in which it is only mass that is of concern to a modeller, who might then treat plant matter and water as combinable aspects of mass. Valves on flows, shown by 'butterfly' or 'luggage label' symbols control the flows. Each represents a graph showing how the rate of flow responds to other variables. The variables involved are shown in the diagram by a broken line linking the valve and a box, indicating a flow of information about an amount. There is no limit to the sorts of boxes and valves between which information may flow. Parameters involved in a valve control are shown inside circles linked to the valve by an information flow. (Three other symbols may be used. Sources and sinks outside the model may be shown in

'cloud' symbols. Auxilliary variables are shown in lozenges and are used for convenience where some summary value is needed for control or output. Delays can be modelled in detail, but have a special compartmental symbol for convenience.)

The control of a single process — decay according to the constant model of Table 1 — is shown in Fig. 7. If one ignores the effects of temperature and water content then this might appear in a PASCAL programme implementing the model as:

```
Dt = 0.1; {iteration interval}
REPEAT
  {First change ALL the amounts in boxes .. }
  PI := PI + (RPgPI - RPIPC - RPICI) * Dt;
  {.. and THEN calculate all the new rates}
  RPICI := PICI * PI; {plus some function of TI and WI}
UNTIL Done;
```

Here PI represents the amount of dry matter in the acrotelm, while RPgPI is the input to it (productivity) and RPIPC is one output (of decayed material into CO<sub>2</sub>). The loop is repeated as many times as the modeller chooses or the programme allows. (The greatest benefits come when modeller and programmer are the same person.)

It is important that no rate should be calculated before all the amounts it depends on have themselves been calculated or, initially, set.

In general, linear relations such as that shown above in the calculation of RPICI, can lead to unstable behaviour if the value of PI, for example, goes outside the designed range. 'Limiting' relations, such as those in Fig. 5, are safer as well as being more realistic.

Once a model has been specified it can be duplicated on a grid and can include interactions between variables at adjacent grid sites. An example of such a simulation is given by Hayward and Clymo (1983).

Simulations of this kind may be realistic in that they produce credible patterns of behaviour. If they have only a few parameters and the variables have differing patterns of response which may be compared with data then it may be possible to optimise the parameter values, as Rydir and Clymo (1989) did. But usually there are too many parameters or too little data. In such cases one may try changing parameter values by, say 10% and finding out which changes produce large changes in behaviour. Understanding may be :



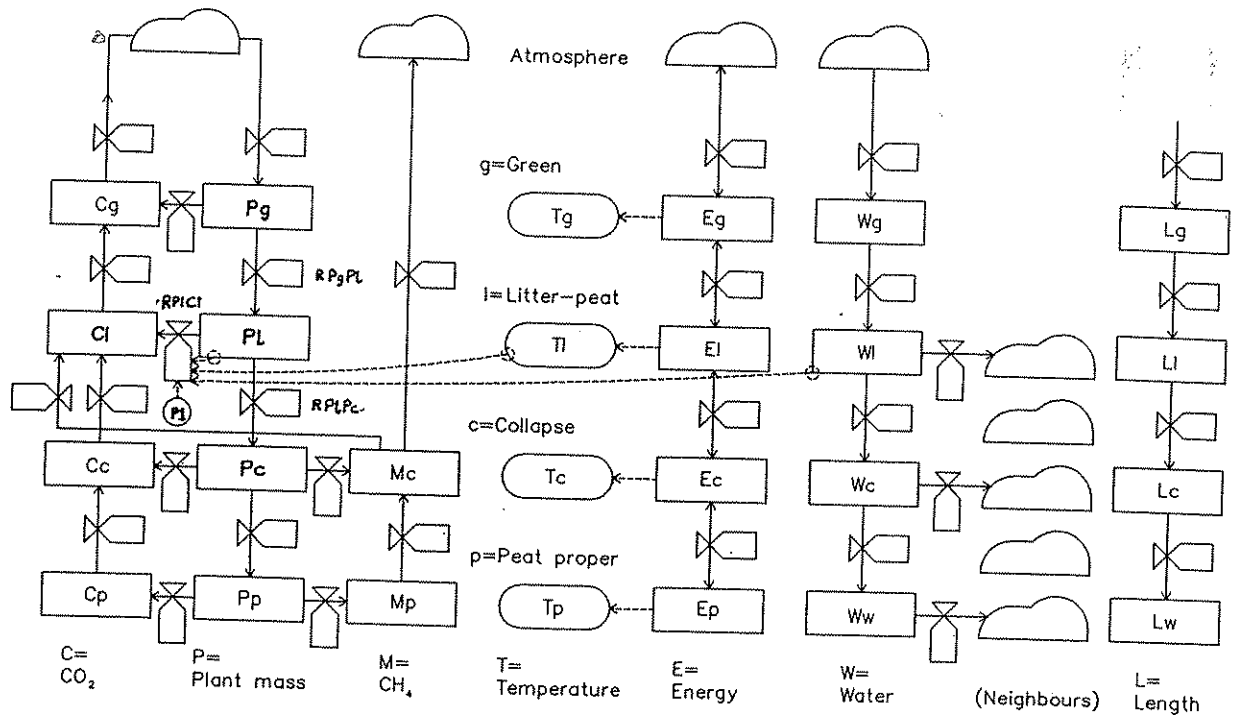

Fig. 7. Outline of a Forrester simulation model of an element of a peatland. It includes flows of  $\text{CO}_2$  (C), plant/peat organic matter (P),  $\text{CH}_4$  (M), energy (E), water (W), 'length' (L), and the derived property temperature (T). The four layers correspond to those in Fig. 2: green (g), litter-peat (l), collapse (c) and peat proper (p). In practice it might be useful to subdivide some of these. In order to run the model the functional relations of all the valves would need to be known or assumed. Only one is shown — that from PI to CI. The rate  $\text{RPICl}$  is shown as determined by the difference equation version of equation (3) and, in an unspecified way by temperature and water content.

casualty. Perhaps the greatest value of such simulations is that they force the model maker to think carefully about what processes are occurring and what controls them.

## CONCLUSIONS

We all make and use models as aids. And as aids they are useful. But they are no substitute for observation and experiment.

## REFERENCES

- Baker, J.H. 1972: The rate of production and decomposition of *Chorisodontium aciphyllum* (Hook, F. and Wils) Broth. — *British Antarctic Survey Bull.* 27:123–129.
- Bragg, O.M. 1982: The acrotelm of Dun Moss — plants, water and their relationships. — PhD thesis, University of Dundee.
- Clymo, R.S. 1984: The limits to peat bog growth. — *Phil. Trans. R. Soc. London B303*: 605–654.
- Clymo, R.S. 1987: The ecology of peatlands. — *Science Progress, Oxford* 71:593–614.
- Clymo, R.S. 1991: Peat growth. — In: Shane, L.C.K. & Cushing, E.J. (eds.), *Quaternary Landscapes*: 76–112. Univ. Minnesota Press, Minneapolis.
- Clymo, R.S. 1992: Productivity and decomposition of peatland ecosystems. — In: Bragg, O.M., Hulme, P.D., Ingram, H.A.P. & Robertson, R.A. (eds.), *Peatland ecosystems and man: an impact assessment*: 3–16. Univ. Dundee and International Peat Society, Dundee and Jyväskylä.
- Clymo, R.S. & Hayward, P.M. 1982: The ecology of *Sphagnum*. — In: Smith, A.J.E. (ed.), *Bryophyte ecology*: 229–289.
- Forrester, J.W. 1961: *Industrial dynamics*. — 464 pp. MIT Press, Cambridge, Massachusetts.
- Hayward, P.M. & Clymo, R.S. 1983: The growth of *Sphagnum*: experiments on, and simulation of, some effects of light flux and water-table depth. — *J. Ecol.* 71:845–863.
- Ingram, H.A.P. 1978: Soil layers in mires: function and terminology. — *J. Soil Sci.* 29:224–227.
- Malmer, N. 1992: Processes of acquisition, transport and deposition of inorganic constituents in surface peat

- layers. — In: Bragg, O.M., Hulme, P.D., Ingram, H.A.P. & Robertson, R.A. (eds.), Peatland ecosystems and man: an impact assessment: 165–174. Univ. Dundee and International Peat Society, Dundee and Jyväskylä.
- Nelder, J.A. & Mead, R. 1965: A simplex method for function minimization. — *Computer Journal* 7:308–313.
- Rydin, H. & Clymo, R.S. 1989: Transport of carbon and phosphorus compounds about Sphagnum. — *Proc. R. Soc. London B237*: 63–84.
- Skellam, J.G. 1972: Some philosophical aspects of mathematical modelling in empirical science with special reference to ecology. — In: Jeffers, J.N.R. (ed.), *Mathematical models in ecology*: 13–28. Blackwell Scientific Publications, Oxford.
- Stuiver, M. & Reimer, P.J. 1986: A computer program for radiocarbon age calibration. — *Radiocarbon* 28: 1022–1030.
- Wallen, B. 1992: Methods for studying below-ground production in mire ecosystems. — *Suo* 43:155–162.
- Warner B.G., Clymo, R.S. & Tolonen, K. 1993: Implications of peat accumulation at Point Escuminac, New Brunswick. — *Quaternary Research* 39 (in press).
- Wildi, O. 1978: Simulating the development of peat bogs. — *Vegetatio* 37:1–17.

## APPENDIX

A general quantitative model of peat dry matter growth may be constructed. First, the rate of decay is specified and proportional losses integrated over the history of a particular element of mass. Secondly, the present total mass is obtained by integrating over all the elements of mass.

Let the dry mass now be  $m$  and that before decay be  $m_0$ , dimensions  $ML^{-2}$ . The proportion remaining is  $\mu = m/m_0$ . Define a decay rule such that the proportional rate of decay,  $\alpha'$  with dimension  $T^{-1}$ , is given by  $\alpha' = f(\mu)$ . A special case is  $\alpha'$  constant. Let  $t$  be time.

$$(1) \quad \text{Then } d\mu/dt = -\alpha'\mu = -\mu f(\mu)$$

$$\text{Hence } \int_0^{\mu_\tau} \frac{1}{\mu f(\mu)} d\mu = - \int_0^\tau dt$$

^

where  $\tau$  is the age of the element of peat. This must be solved and rearranged to give  $\mu = f(\tau)$ .

(2) The total mass at time  $T$  is  $M_T$  with dimensions  $ML^{-2}$ . Let  $p'$  be the rate of addition (productivity) of dry matter with dimensions  $ML^{-2}T^{-1}$

$$M_T = p' \int_0^T \mu d\tau.$$

This process requires two successive integrations with an intervening rearrangement to make  $\mu = f(\tau)$ . For all but simple decay rules there may be no analytic solution. Three specific solutions are given in Table 1.